

Article number: 20240435370

Description: E+G Telescope-Lear motion bearings GN 2404-35-370

Measures

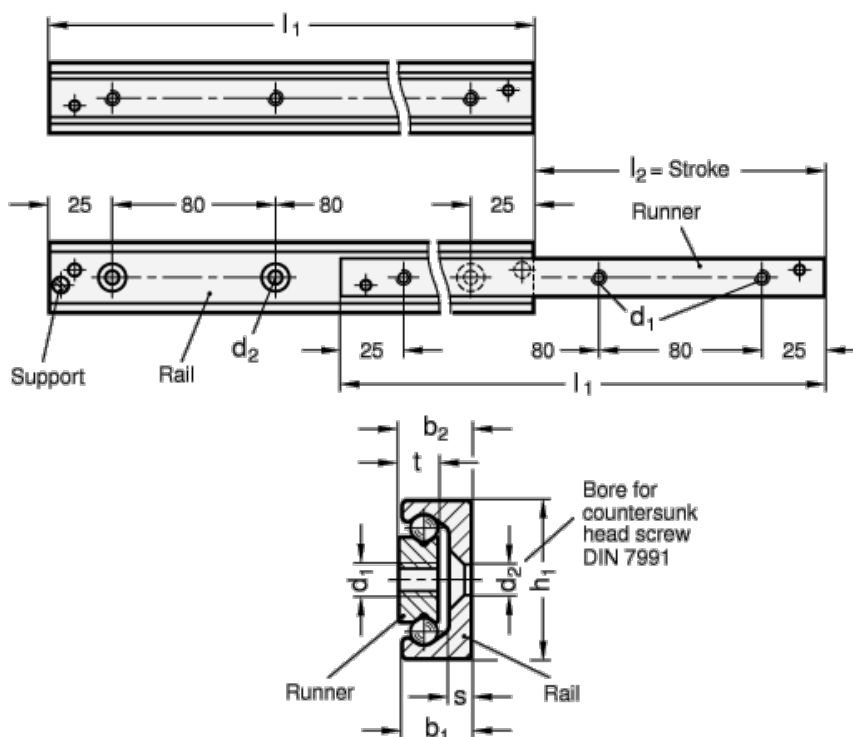

$b_1 = 16.5$

$b_2 = 17$

$d_1 = M6$

$d_2 = 6.5$

$h_1 = 35$

$L_1 = 203 - 370$

$s = 3.5$

$t = 10$

Weight in (g) = 1210